

## Temperature rise and DC current capability tests of star-point reactor used in HVDC transmission

<sup>a</sup>Dalibor Filipović-Grčić, <sup>c\*</sup>Božidar Filipović-Grčić, <sup>b</sup>Igor Žiger, <sup>b</sup>Danijel Krajtner,  
<sup>a</sup>Danijel Brezak, <sup>a</sup>Rajko Gardijan  
<sup>a</sup>Končar - Electrical Engineering Institute Inc., Zagreb, Croatia  
<sup>b</sup>Končar - Instrument Transformers Inc., Zagreb, Croatia  
<sup>c</sup>University of Zagreb, Faculty of Electrical Engineering and Computing, Croatia

### SUMMARY

Star-point reactors are grounding devices installed in HVDC stations between the converter transformer secondary side and AC side of converter arms to provide a reference to ground. Such reactors are used as high-impedance grounding on the converter side of power transformers, providing high impedance path for the fundamental harmonic (i.e. 50 or 60 Hz) and a low impedance path for DC current, eliminating DC current flowing through the transformer windings. Temperature rise and DC current capability tests of 420 kV star-point reactor are presented in this paper. The purpose of temperature rise test is to verify that temperatures that can damage the insulation of star-point reactor will not be reached with the specified service conditions. The temperature rise test was carried out according to the requirements of the IEC 61869-3 standard and client's request which included simultaneous application of fundamental, 3<sup>rd</sup> harmonic voltage and DC excitation. The inclusion of 3<sup>rd</sup> harmonic excitation of an amplitude up to 15% simulates voltage harmonic distortion which may appear in the power system at the location of star-point reactor installation. Prior to temperature rise test, DC current capability test was performed. The goal of this test is to determine the value of DC current at which the saturation point is reached. DC current is injected through star-point reactor while AC voltage is applied. Two different cases are considered regarding AC voltage: test with fundamental voltage harmonic and test with fundamental voltage harmonic with superimposed third voltage harmonic. Test circuit is proposed which is suitable for generation of complex voltages composed of fundamental harmonic and superimposed third harmonic with amplitudes up to 15% of the applied fundamental harmonic. The proposed test circuit was also used during the temperature rise test and it is applicable for testing of HV equipment with rated voltage up to 420 kV.

### KEYWORDS

Temperature rise test, star-point reactor, DC current capability test, HVDC transmission.

## 1. INTRODUCTION

HVDC transmission enables economic power delivery across long distances, as well as interconnections between systems of different frequencies or networks that cannot be synchronized. HVDC transmission can be also used in cases when direct connection between two AC systems with the same frequency or a new connection within a meshed grid may be impossible because of system instability, too high short-circuit levels or undesirable power flow scenarios. Furthermore, HVDC grids are a very attractive solution for interconnection of offshore wind power plants to add an additional level of redundancy, flexibility and efficiency to the expansive power system [1].

With the increasing number of converter stations being built, the requirements on high voltage apparatus also change. One of such requirements is the simultaneous AC and DC loading of high voltage apparatus. While there are several types of units which could be subject to simultaneous AC and DC loading, the focus of this paper is placed on earthing reactors, also known as star-point reactors. These special grounding devices are installed between the converter transformer secondary side and AC side of converter arms to provide a reference to ground in the converter station [2]. These units are mostly used in HVDC stations with modular multilevel converters (Fig. 1) and they consist of three star-connected inductors with their neutral connected to the ground [3].

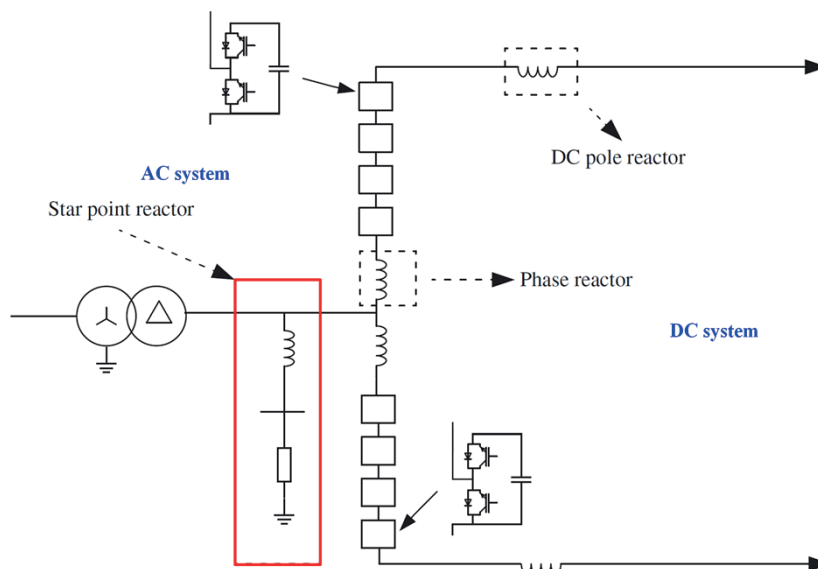

Figure 1. Star-point reactor connected between the converter transformer and the valves

When it comes to wind-power plant application, due to the space limitations at the offshore platform, normally the star-point reactor is installed at the onshore converter station. Such reactors are used as high-impedance grounding on the converter side of power transformers, providing high impedance path for the fundamental harmonic (i.e. 50 or 60 Hz) and a low impedance path for DC current, eliminating DC current flowing through the transformer windings. The predominant effect that DC current has on the operational characteristics of a power transformer is half cycle saturation [4], [5]. This leads to increased harmonic distortion, increased reactive power losses, overheating and elevated acoustic noise emissions. The DC current flowing through the star-point reactor may also cause saturation and consequently the above stated negative effects.

Star-point reactor is a device which is similar to inductive voltage transformer but without the low voltage winding. Therefore, for testing of star-point reactors standard for inductive voltage transformers is the most suitable [6]. However, requirements in available standards are

not completely appropriate for star-point reactors, which are a novel product concept. Therefore, several special tests that demonstrate the specialities of star-point reactors need to be introduced. These tests reflect the application modes of such units, as well as realistic conditions in the power network, which are not considered in [6]. DC current capability test is performed to check the conditions which can drive reactor's core into saturation [7]. Temperature rise tests on inductive voltage transformers are normally performed with power frequency voltage, but for star-point reactor the client's request was to superimpose third harmonic voltage up to 15% of the applied fundamental harmonic voltage. These requirements cannot be fulfilled with standard test equipment normally found in HV laboratories. Additional test circuit is proposed for generating third harmonic voltage equipped with blocking and passing filters and compensation.

## 2. CHARACTERISTICS OF 420 kV OPEN-CORE STAR-POINT REACTOR

Star-point reactor data are given in Table I and electrical scheme is shown in Fig. 2, where A is top end terminal, MT is measuring terminal and N is ending of the primary winding.

Table I. Star-point reactor data

Rated voltage	420/ $\sqrt{3}$ kV
Continuous 3 <sup>rd</sup> harmonic voltage	37.6 kV
Rated resistance at 75 °C	> 7500 $\Omega$
Maximum DC current	80 mA
Maximum simultaneous current	125 mA

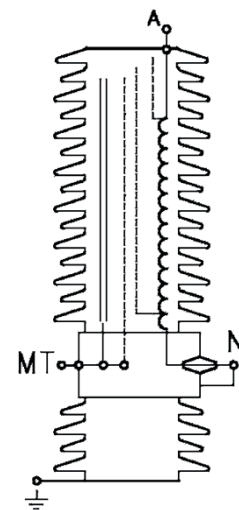

Figure 2. Electrical scheme of star-point reactor

Magnetic characteristic of 420 kV star-point reactor with open-core is measured according to [8]. An indirect method is needed to get the magnetic characteristic since the linked flux cannot be measured directly. Calculation of the magnetic characteristic is possible from measurements made of the instantaneous values of the current and voltage when an AC voltage of sufficient magnitude to cause saturation is applied for at least one cycle. If a measurement of the characteristic is requested for currents above the maximum service current, a method shall be used that does not overload the reactor, for instance the DC method which is applied in this paper. The magnetic characteristic for currents well above nominal current can then be evaluated. By charging the reactor with a DC current (higher than nominal peak current) the magnetic linked flux will increase following the magnetisation curve (switch 1 and 3 are closed in Figure 3). The reactor should be charged as quickly as possible in order not to introduce a resistance change caused by temperature rise. The reactor is then short-circuited and the decaying current  $i(t)$  is recorded (switch 2 closes and switch 1 and 3 open). From this decaying current, the magnetic characteristic can be determined by using the following expressions derived from the circuit shown in Fig. 3:

$$U_L + U_R = 0; U_L = -\frac{d\psi(t)}{dt}; U_R = R \cdot i(t), \quad (1)$$

$$\frac{d\psi(t)}{dt} = R \cdot i(t), \quad (2)$$

$$\psi(t) = \int_0^T R \cdot i(t) dt, \quad (3)$$

where  $U_L$  is voltage drop across inductance  $L$ ,  $U_R$  is voltage drop across  $R$  which is the known ohmic resistance of the whole circuit (winding + connecting leads + current shunt) and  $T$  is time sufficient for current and flux to drop to negligible value. The total linked flux change  $\psi(t)$  is determined from expression (3).

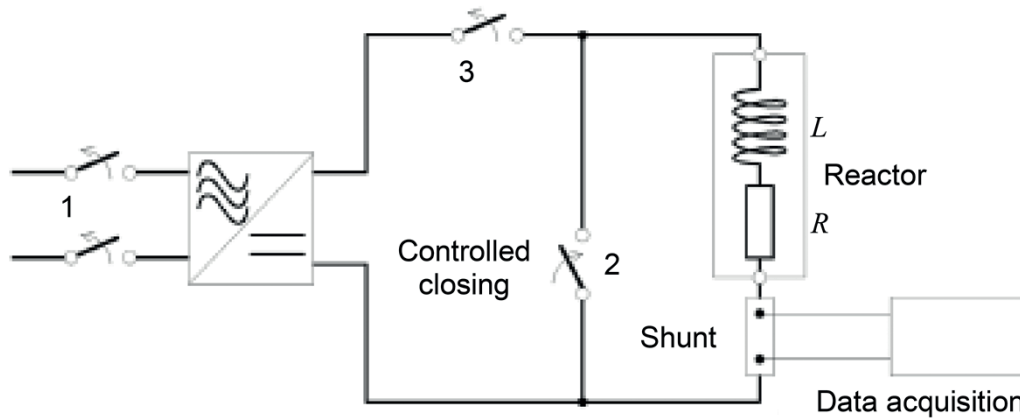

Figure 3. Circuit for measurement the magnetic characteristic according to [8]

Finally, the magnetic characteristic of star-point reactor derived from the measurements is shown in Fig. 4.

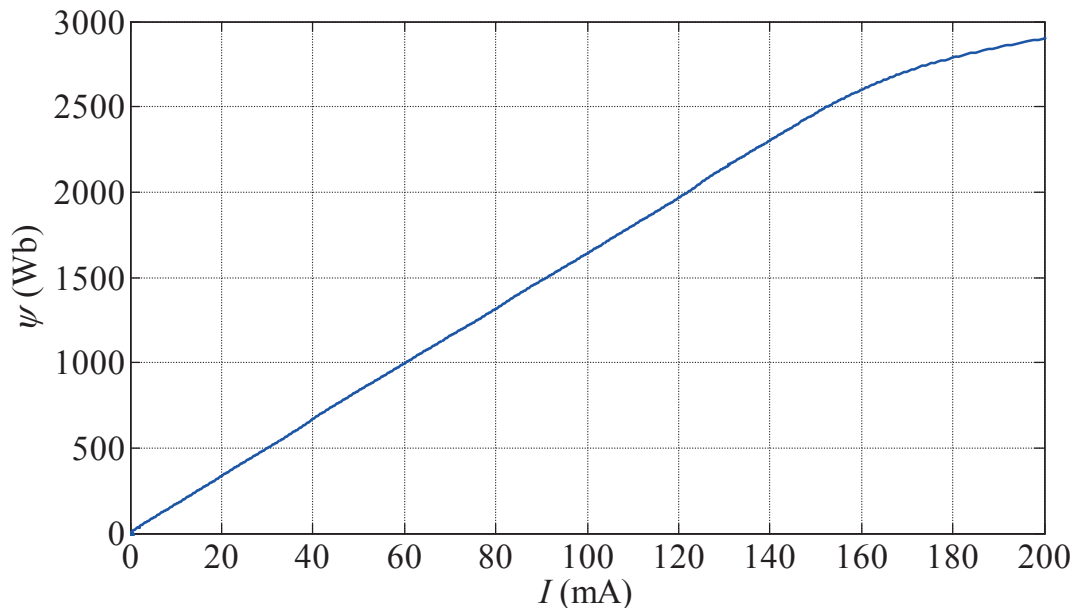

Figure 4. Measured magnetic characteristic of 420 kV open-core star-point reactor

Prior to temperature rise test, DC current capability of star-point reactor with respect to saturation was checked.

### 3. DC CURRENT CAPABILITY TEST

The goal of DC current capability test is to determine the value of DC current at which the saturation point is reached. In this test, DC current is injected through star-point reactor while

AC voltage is applied. Two different cases are considered regarding AC voltage: test with fundamental voltage harmonic (50 Hz) and test with fundamental voltage harmonic with superimposed third voltage harmonic (150 Hz), which simulates voltage harmonic distortion which may appear in the power system at the location of star-point reactor installation.

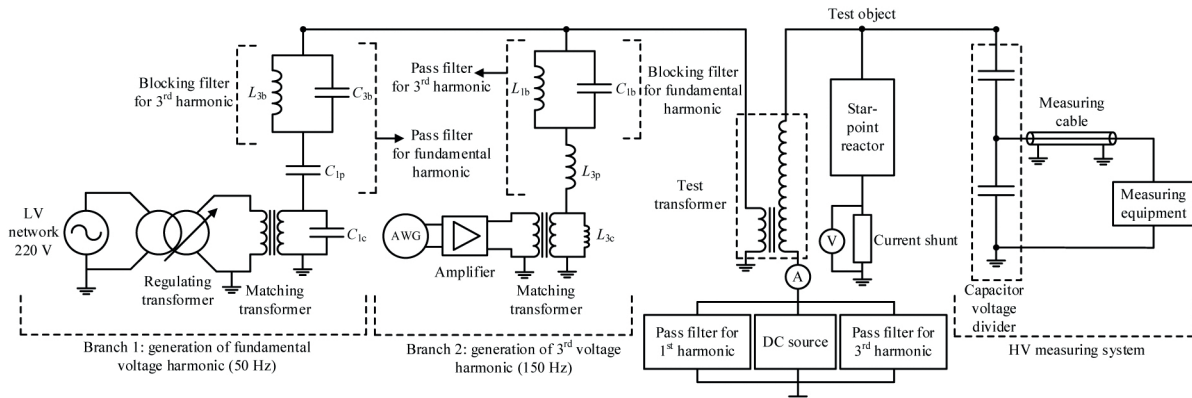

Figure 5. Test circuit for DC current capability test

Proposed test circuit for performing DC current capability test is shown in Fig. 5. Fundamental frequency voltage is generated directly from low voltage network (220 V) through regulating transformer and matching transformer (branch 1). In this branch, a blocking filter ( $L_{3b}$ ,  $C_{3b}$ ) for 3<sup>rd</sup> harmonic and a pass filter ( $L_{3b}$ ,  $C_{3b}$ ,  $C_{1p}$ ) for fundamental harmonic are connected. Compensation capacitance  $C_{1c}$  for fundamental harmonic is connected in parallel with matching transformer. 3<sup>rd</sup> voltage harmonic is generated from arbitrary waveform generator (AWG) signal which is amplified by low frequency amplifier and afterwards stepped up by the matching transformer (branch 2). In this branch, a blocking filter ( $L_{1b}$ ,  $C_{1b}$ ) for fundamental harmonic and a pass filter ( $L_{1b}$ ,  $C_{1b}$ ,  $L_{3p}$ ) for 3<sup>rd</sup> harmonic are connected. Compensation inductance  $L_{3c}$  for 3<sup>rd</sup> harmonic is connected in parallel with matching transformer. One of the main benefits of the test circuit is that it can be easily adapted for injection of higher harmonics (e.g. the 3<sup>rd</sup> harmonic) of a significant amplitude (5-15% of the applied fundamental voltage), which is a very common requirement for inductive voltage transformers and star-point reactors [9]. The test circuit shown in Fig. 5 is suitable for testing of HV equipment with rated voltage up to 420 kV. Test arrangement in HV laboratory during the DC current capability test is shown in Fig. 6.

### 3.1. Test with fundamental voltage harmonic and injected DC current

In this test, a 50 Hz voltage  $U_p=420/\sqrt{3}=242.5$  kV is applied on the star-point reactor, while DC current is gradually increased to determine the saturation point. Below the saturation point, as DC current increases, AC component of current does not change since applied AC voltage is constant. Above saturation point, AC current through the reactor increases significantly. Measurement results show that the star-point reactor starts to exhibit saturation when the applied DC current is around 112 mA. Current-voltage waveforms recorded at star-point reactor for operating points without and with saturation are shown in Figs. 7 and 8. Influence of AC primary voltage increase on reactor saturation is investigated. During this test, constant DC current of 80 mA was injected through reactor according to client's request. This value of DC current is equal to maximum DC current which is expected at the site of star-point reactor installation in the HVDC substation. Current-voltage waveforms recorded at star-point reactor for primary voltage  $U_p=241.3$  kV and  $U_p=265.6$  kV are shown in Figs. 9 and 10, respectively.

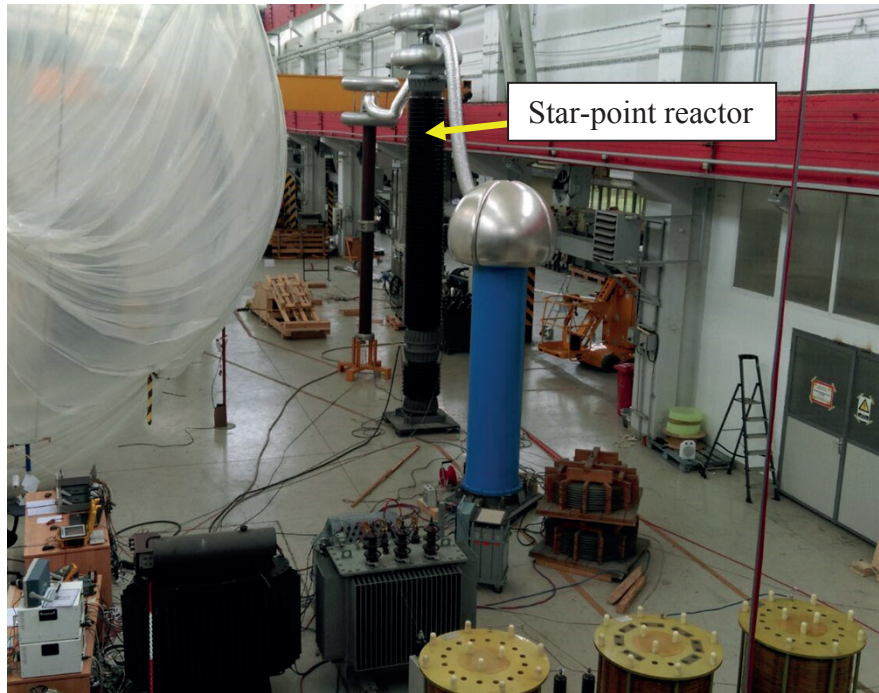

Figure 6. Test arrangement in HV laboratory during the DC current capability test

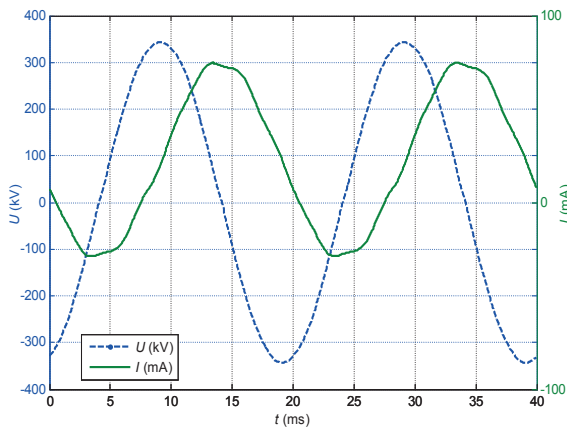

Figure 7.  $U$ - $I$  waveforms in the region without saturation ( $I_{DC}=22.0$  mA)

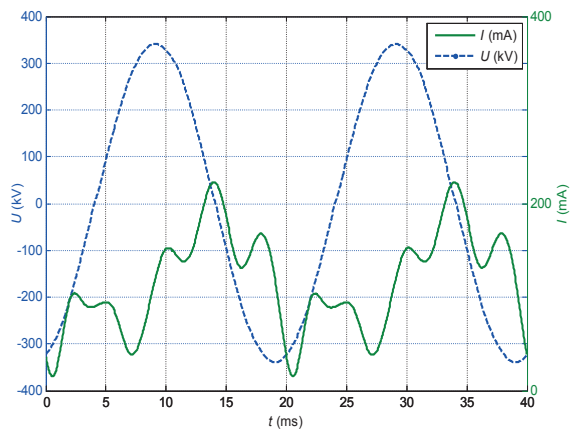

Figure 8.  $U$ - $I$  waveforms in the saturation region ( $I_{DC}=120.4$  mA)

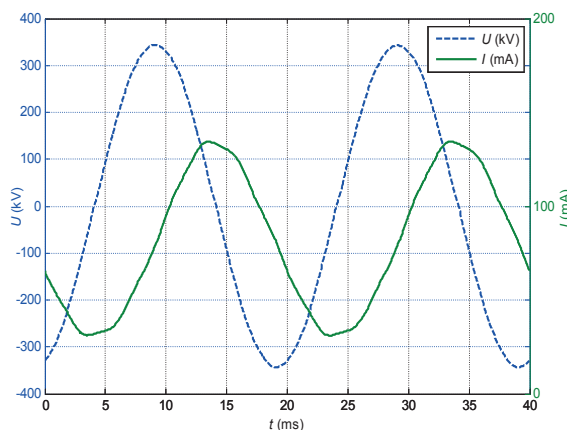

Figure 9.  $U$ - $I$  waveforms for  $U_p=241.3$  kV ( $I_{DC}=80$  mA)

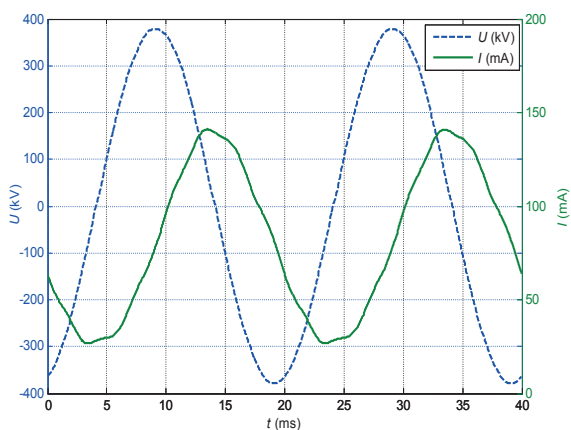

Figure 10.  $U$ - $I$  waveforms for  $U_p=265.6$  kV ( $I_{DC}=80$  mA)

Tests results show that there was no notable change of ratio between the applied primary voltage  $U_p$  and current through shunt reactor. This indicates that AC primary voltage increase did not cause saturation of star-point reactor.

### 3.2. Test with fundamental voltage harmonic, superimposed third voltage harmonic and injected DC current

The test was carried out at rated primary 50 Hz voltage  $U_p=242.5$  kV, with superimposed 37.7 kV of the 3<sup>rd</sup> harmonic (150 Hz), corresponding to 15.5% of rated voltage, while DC current is gradually increased up to 80 mA. Current-voltage waveforms for  $I_{DC}=0$  mA and  $I_{DC}=80$  mA are shown in Figs. 11 and 12, respectively.

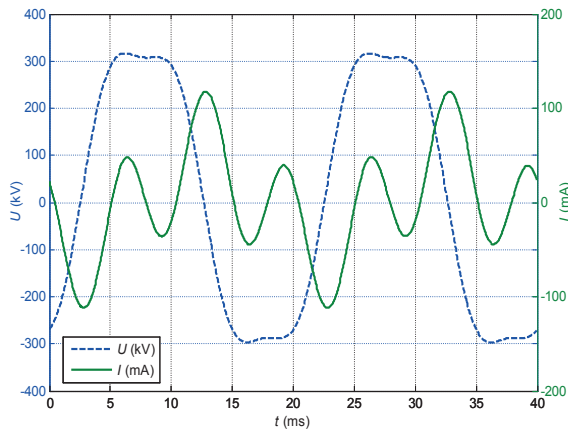

Figure 11.  $U$ - $I$  waveforms for  $I_{DC}=0$  mA

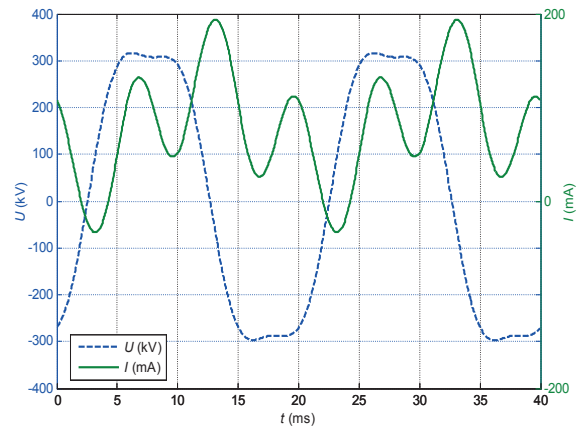

Figure 12.  $U$ - $I$  waveforms for  $I_{DC}=80$  mA

From the test results there was no notable change of AC current through the reactor. Saturation point has not been reached at 80 mA of DC current. Influence of AC 50 Hz primary voltage increase on reactor saturation is investigated. During the test, constant DC current of 80 mA was injected through reactor. Current-voltage waveforms recorded at star-point reactor for primary voltage  $U_p=248.6$  kV and  $U_p=260.1$  kV are shown in Figs. 13 and 14, respectively.

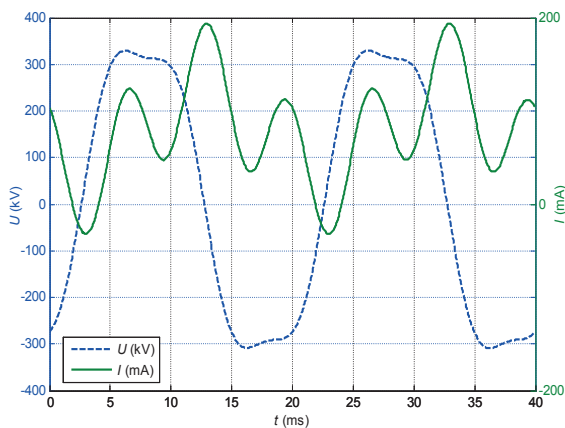

Figure 13.  $U$ - $I$  waveforms for  $U_p=248.6$  kV ( $I_{DC}=80$  mA)

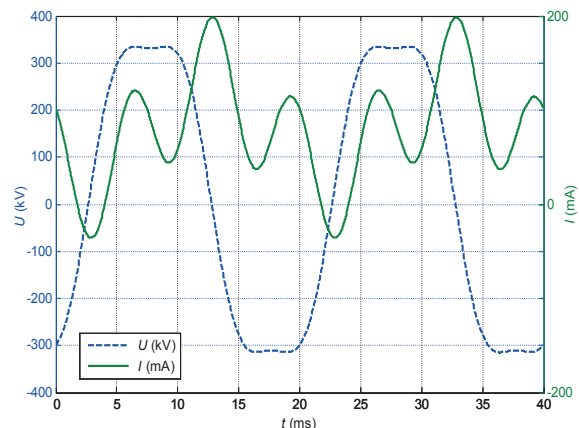

Figure 14.  $U$ - $I$  waveforms for  $U_p=260.1$  kV ( $I_{DC}=80$  mA)

Tests results show that there was no notable change of ratio between the applied 50 Hz primary voltage  $U_p$  and current through shunt reactor. This indicates that primary voltage increase did not cause saturation of star-point reactor.

#### 4. TEMPERATURE RISE TEST

The purpose of this test is to verify that temperatures that can damage the insulation will not be reached with the specified service conditions. The temperature rise test was carried out according to the requirements of [6] and client's request. For this test, star-point reactor was mounted vertically in a manner representative of the mounting in service. Temperature rise tests are normally performed with power frequency voltage, but the client request was to superimpose third harmonic voltage up to 15% of the applied fundamental harmonic voltage. These requirements cannot be fulfilled with standard equipment normally found in HV laboratories. Therefore, an additional circuit for generating third harmonic voltage needs to be used along with blocking and passing filters and compensation. The test was carried out at rated primary 50 Hz voltage 242.5 kV, with superimposed 37.6 kV of the 3<sup>rd</sup> harmonic (150 Hz) and DC current 80 mA. For the temperature rise test, the same test setup is used as for the DC current capability test (Fig. 5).

Additional measuring equipment for temperature measurement and winding resistance measurement was used during the temperature rise test. The temperature rise of winding is measured by the increase in resistance (*U-I* method). Flange temperature and top oil temperature are measured with cuprum-constantan thermocouples. Thermocouple layout during the temperature rise test is shown in Fig. 15.

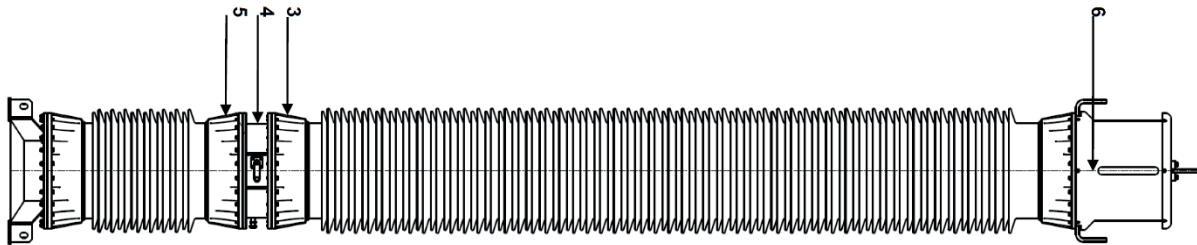

Figure 15. Thermocouple layout during the temperature rise test

Six thermocouples are used during the temperature rise test. Thermocouples 1 and 2 are used for measurement of ambient temperature, thermocouples 3-5 for measurement of flange temperature and thermocouple 6 for measurement of top oil temperature. Ambient temperature is measured with two thermocouples placed in oil containers (volume 0.5 litre). It is considered that a star-point reactor reached steady-state temperature when the rate of temperature rise does not exceed 1 K/h. The temperature rises of windings, magnetic circuits and any other parts of reactor shall not exceed values given in Table II [10], when operating under specified rated conditions. The temperature rise of the windings is limited by the lowest class of insulation either of the winding itself or of the surrounding medium in which it is embedded.

Table II. Limits of temperature rise for various parts, materials and dielectrics of star-point reactors [10]

Parts of star-point reactor	Temperature rise limit (K)
top oil	50
top oil, hermetically sealed	<b>55</b>
winding average	60
winding average, hermetically sealed	<b>65</b>
other metallic parts in contact with oil	as for winding

Results of temperature rise test are shown in Table III, where  $T_a$  represents average ambient temperature,  $T_f$  average flange temperature,  $T_o$  top oil temperature,  $R_w$  winding resistance and  $T_w$  winding temperature.



Table III. Results of temperature rise test

	$T_a$	$T_f$	$T_o$	$R_w$	$T_w$
Initial state (cold)	23.9°C	23.9°C	23.9°C	7450 $\Omega$	23.9°C
4 hours before steady-state	25.7°C	33.7°C	42.9°C	7689 $\Omega$	32.2°C
2 hours before steady-state	26.3°C	34.5°C	43.4°C	7701 $\Omega$	32.6°C
Steady state	26.7°C	35.0°C	43.9°C	7715 $\Omega$	33.1°C
Temperature rise	-	8.3 K	17.2 K	-	6.4 K

Temperature rise is less than 65 K for winding average temperature rise and 55 K for oil temperature rise, as shown in Table II. According to the test results, star-point reactor successfully passed the temperature rise test.

## 5. CONCLUSION

With the increasing number of HVDC converter stations being built, the requirements on high voltage apparatus also change. One of such requirements is the simultaneous AC and DC loading of high voltage apparatus. Although the applicable international standards for testing such apparatus are subject to constant further development, they do not cover all specific requests from the utilities based on different conditions in the power network. This leads to an increase in the number of special tests which are partly covered or are not covered at all by the available international standards.

In this paper, temperature rise and DC current capability tests of 420 kV star-point reactor with open core used in HVDC transmission are presented. Prior to performing these tests, a magnetic characteristic of reactor was measured by applying DC current charging/discharging method. Temperature rise tests are normally performed with power frequency voltage, but for star-point reactor the client's request was to superimpose third harmonic voltage up to 15% of the applied fundamental harmonic voltage to consider the voltage harmonic distortion which may appear in the power system at the location of star-point reactor installation. This test cannot be performed with standard test equipment normally found in HV laboratories. Therefore, a new test circuit is proposed for generating third harmonic voltage equipped with blocking and passing filters and compensation. Test circuit is suitable for testing of HV equipment with rated voltage up to 420 kV. DC current capability test is performed to determine the value of the DC current at which the saturation point is reached. In this test, DC current is injected through star-point reactor while AC voltage is applied. Two different cases are considered regarding AC voltage: test with fundamental voltage harmonic and test with fundamental voltage harmonic with superimposed third voltage harmonic. Influence of AC primary voltage increase on reactor saturation is investigated. For performing the DC current capability test, the same test circuit is used as for the temperature rise test.

Currently more than 200 HVDC systems are operating around the world and many new HVDC projects, both overhead line and cable projects, are being planned. HVDC applications are increasing steadily to meet increasing load demands or to interconnect renewable generation resources, such as wind and solar, to the main transmission network because of technical and economic advantages. Power electronics is a key enabling technology for both renewable energy generation and HVDC transmission, but also has important impacts on grid stability, high voltage apparatus and power quality because of its fast control and sensitivity to faults and other abnormal conditions in the grid. In the future it is to be expected that the number of special tests in high-voltage laboratories, such as those described in the paper, will increase due to the growing number of HVDC stations and the increasing demands on the reliability of the high voltage apparatus required by the utilities.

## REFERENCES

- [1] A. J. Beddard, "Factors Affecting the Reliability of VSC-HVDC for the Connection of Offshore Windfarms", PhD thesis, University of Manchester, School of Electrical and Electronic Engineering, 2014.
- [2] K. Sharifabadi, L. Harnefors, H.-P. Nee, S. Norrga, R. Teodorescu, "Design, Control, and Application of Modular Multilevel Converters for HVDC Transmission Systems", Wiley-IEEE Press; 1<sup>st</sup> edition, October 2016.
- [3] H. Wang, G. Tang, Z. He, J. Yang, "Efficient Grounding for Modular Multilevel HVDC Converters (MMC) on the AC Side", IEEE Transactions on Power Delivery, vol. 29, no. 3, pp. 1262-1272, June 2014.
- [4] A. K. Zeimer, "The Effect of DC Current on Power Transformers" University of Southern Queensland, Faculty of Engineering and Surveying, October 2000.
- [5] W. Xu, T. G. Martinich, J. H. Sawada, Y. Mansour, "Harmonics from SVC transformer saturation with direct current offset", IEEE Transactions on Power Delivery, vol. 9, no. 3, pp. 1502-1509, July 1994.
- [6] IEC 61869-3, "Instrument transformers - Part 3: Additional requirements for inductive voltage transformers", 2011.
- [7] I. Žiger, D. Krajtner, D. Filipović-Grčić, "DC current capability of high voltage apparatus based on the open-core concept", in Press, Electric Power Systems Research, 2017 (doi: 10.1016/j.epsr.2017.10.017).
- [8] IEC 60076-6, "Power transformers - Part 6: Reactors", 2007.
- [9] D. Filipović-Grčić, B. Filipović-Grčić, D. Krajtner, "Frequency response and harmonic distortion testing of inductive voltage transformer used for power quality measurements", Procedia Engineering, volume 202, pp. 159-167, 2017.
- [10] IEC 61869-1, "Instrument transformers - Part 1: General requirements", 2007.