

Harmonic Performance Analysis of Static Var Compensator Connected to the Power Transmission Network

^aIvana Damjanović, ^aFrano Tomašević, ^aIvica Pavić, ^{a*}Božidar Filipović-Grčić, ^bAlan Župan

^aUniversity of Zagreb, Faculty of Electrical Engineering and Computing, Croatia

^bCroatian Transmission System Operator Ltd., Zagreb, Croatia

SUMMARY

The static var compensator (SVC) is a device which is designed to compensate reactive power, increase voltage stability and to reduce voltage fluctuations. Thyristor controlled reactors (TCRs) are composed of reactors in series with bidirectional pair of thyristors. Current through reactors can be continuously controlled by changing the firing angle of thyristor valves, thus the inductive power can be easily controlled. Typical applications of TCRs in AC systems are voltage stabilization and temporary overvoltage reduction, stability improvement, damping of power oscillations and load balancing.

In this paper, harmonic performance analysis of SVC equipped with TCRs is presented. SVCs utilizing TCRs generate harmonic currents and therefore it is necessary to determine the effect of harmonics generated by the SVC on the power system and its elements. This includes interaction of the SVC with the system, the SVC performance under balanced and unbalanced operating conditions and finally, evaluation of countermeasures such as installation of harmonic filters. In order to carry out these analysis, it is necessary to determine harmonic characteristics of the network at the point of SVC connection, existing levels of harmonics, and to know appropriate standards regarding acceptable harmonic levels in the power system. Since harmonic distortions in the system are caused by the interaction between SVC and the system, all system contingencies which may affect system's frequency response should be evaluated. Detailed power system model should be considered to make sure that parallel resonance points of system do not directly coincide with characteristic harmonics from the SVC. Harmonics generated by SVCs are largely dependent on the operating point within the SVC characteristic. A conservative approach is to use the maximum values of harmonics generated within the spectrum irrespective of the operating point. The results of harmonic performance analysis are important for appropriate design of SVC. Harmonic performance analysis related to SVC application which are presented in this paper include the determination of: frequency response of the transmission network impedance required for the specification and design of filters; the effects of SVC generated harmonics on the power system; the overall filter requirements and countermeasures to reduce harmonics to acceptable levels.

KEYWORDS

Static Var Compensator (SVC), thyristor-controlled reactors, harmonic performance study, filter design, frequency response of the network.

1. FUNDAMENTALS OF POWER SYSTEM HARMONICS

1.1. Harmonic Sources

Harmonic sources cause harmonic distortion by injecting the current of a given harmonic spectra into the system. Causes of harmonics may be divided into two groups: power electronics devices and devices with nonlinear voltage and current relationship. Examples of the harmonic sources from the first group are SVC and TCR, while the second group includes nonlinear devices such as arc furnaces and saturated transformers.

TCRs are composed of reactors in series with bidirectional pair of thyristors which continuously control amount of absorbed reactive energy by changing the firing angle. The structure of TCR and its waveform are in Figure 1.1.

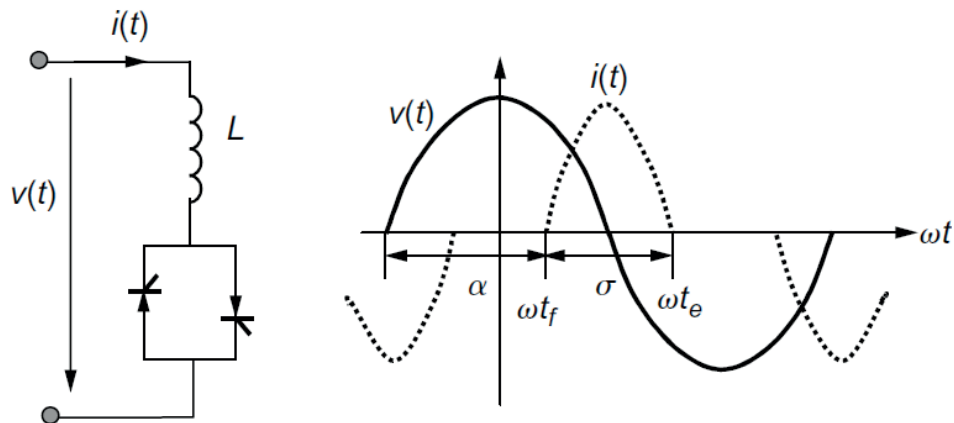

Figure 1.1 Thyristor controlled reactor and its current and voltage waveforms [1]

The thyristor control angle α at the TCR is typically between 90° and 180° and is defined from the zero crossing of the voltage appearing across its terminals. At the firing angle 90° , thyristors leak the full sinusoidal current to the TCR, while at 180° the current reduces to zero. Between these limits of the control angle, there are current waveform distortions which are equal in the positive and negative half-cycles, causing only odd-order harmonics. Multiple different harmonics are generated at same firing angle, and the typical amplitude values of a given harmonic in relation to the rated current depending on firing angle are shown in Figure 1.2. The TCR, modeled in this paper, has an anti-parallel-connected thyristor pair for each phase as shown in Figure 1.1, connected in delta giving a 6-pulse unit. Assuming that the reactors in each branch are identical and that all thyristors fire with equal firing angles, SVC generates only odd harmonics while zero sequence triplen harmonics remain trapped inside delta, thus reducing the harmonic injection into the power system. On the preliminary consideration it can be deduced that the TCR will produce harmonics of the order $6p \pm 1$ where $p = 0, 1, 2, 3 \dots$ (5^{th} , 7^{th} , 11^{th} , 13^{th} ... harmonic). The most significant influence on power quality have 5^{th} and 7^{th} harmonic because their amplitudes are the most dominant.

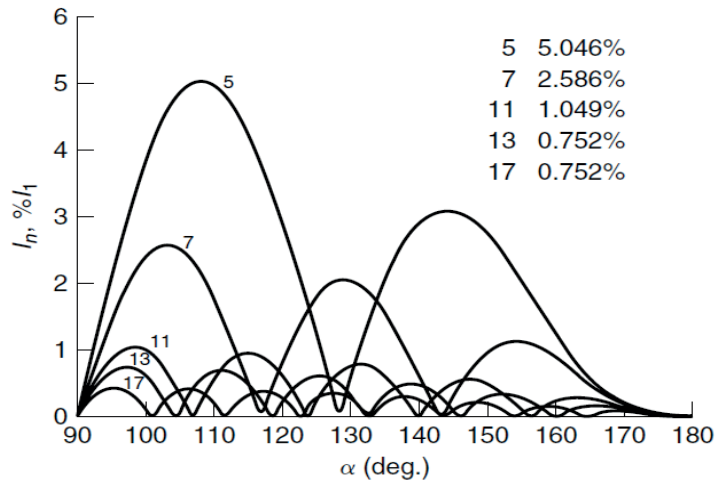

Figure 1.2 Current harmonics of TCR depending of thyristor firing angle [2]

1.2. Standardization of Harmonic Levels

Total harmonic distortion (THD) and individual harmonic distortion (IHD) are widely used power quality indicators. According to literature [3], these factors for voltage distortion are defined as:

$$IHD_n = \frac{U_n}{U_1} * 100\%, \quad (1)$$

$$THD = \frac{U_H}{U_1} * 100\%, \quad (2)$$

$$U_H = \sqrt{(U_2^2 + U_3^2 + U_4^2 + U_5^2 + U_5^2 + U_6^2 + \dots + U_n^2)}, \quad (3)$$

where n is harmonic order. Equations (1), (2) and (3) also apply to the calculation of current distortion.

Concerning voltage harmonic distortion, IEEE 519 standard [4] defines limits shown in Table I as a function of the system voltage level. The recommended limits apply only at the point of common coupling (PCC) and should not be applied to either individual pieces of equipment or at locations within a user's facility. In most cases, harmonic voltages and currents at these locations could be found to be significantly greater than the limits recommended at the PCC due to the lack of diversity, cancellation, and other phenomena that tend to reduce combined effects of multiple harmonic sources to levels below their algebraic summation.

Table I Individual and total voltage harmonic distortion limits [4]

Bus voltage U at PCC	IHD (%)	THD (%)
$U \leq 1.0$ kV	5.0	8.0
1 kV $< U \leq 69$ kV	3.0	5.0
69 kV $< U \leq 161$ kV	1.5	2.5
161 kV $< U$	1.0	1.5

According to the Croatian grid code, voltage THD in normal operating conditions caused by either generator or user connection at the withdrawal and injection point shall typically amount to at most:

- 1.5% at 400 kV and 220 kV levels;
- 3.0% at 110 kV level.

The above given values refer to the 95% of the 10-minute averages of effective voltage values for the period of one week.

1.3. Harmonic Analysis

Power system harmonic analysis includes network frequency response analysis and harmonic power flow analysis and is used for system planning, equipment design, etc. Frequency response characteristic of a network helps in verifying whether resonance conditions exist and how to mitigate them. Frequency scan is generally determined at network locations where nonlinear loads, capacitor banks, or harmonic filters are connected. A harmonic power flow calculation gives an insight into the harmonic voltages and currents of the observed system operating point, which allows to check whether the distortions are within the defined limits.

2. HARMONIC FILTERING TECHNIQUES

Harmonic filters are used to prevent adverse effects of harmonics and can generally be classified into passive and active filters. Their basic difference stands on whether they provide filtering action within a selected bandwidth (passive) or as a result of a real-time monitoring process (active). Hybrid filters are a combination of the two mentioned groups.

Passive filters are most commonly used and can be designed as single-tuned or band-pass [5]. Single-tuned filters represent a low impedance for the harmonic frequency that needs to be filtered out, while the band-pass devices filter harmonics of a given frequency bandwidth.

2.1. Single-tuned filters

The most commonly used filter type is single-tuned, which is a series combination of a capacitance and an inductance whose values are determined in a way that their combination achieves serial resonance at tuned frequency. The interaction of the filter and the source impedance results in a parallel resonance. If multiple single-tuned filters are used, it is necessary to take into account that each filter branch provides a certain amount of reactive compensation. In this case, a parallel resonant frequency exists for every individual passive filter.

2.2. IEEE 18 standard

Filter capacitors are designed to operate continuously at or below their rated voltage. Recommended operation values for filter capacitors are defined in IEEE 18 standard [6]. Maximum limits shown in Table II for the operation of shunt capacitors in the power system including current, reactive power, and voltage across the capacitor units are basic for filter design.

Table II Maximum operating limits for shunt capacitors

Q (kvar)	135% of rated reactive power
Voltage (rms)	110% of rated rms voltage
Voltage (peak)	120% of rated peak voltage, including harmonics, but excluding transients
Current (rms)	135% of nominal rms current based on rated reactive power and rated voltage

2.3. Methodology for design of tuned harmonic filters

Determining the technical characteristics of the filter is an iterative procedure in which the initial presumed nominal filter values (rated power and rated voltage) are checked according to the limits from Table II. It is necessary to know harmonic distortions created by the device for which the filter is dimensioned and existing distortions of current and voltage in the network.

SVC substation considered in this paper consist of two TCR branches with total reactive power 250 Mar connected to the 220 kV transmission network via transformer 242/26 kV. TCR branches produce current harmonics as shown in Figure 1.2. Filters for 5th and 7th harmonic are designed assuming that harmonics in the network are generated only by SVC operation.

2.3.1. Verifying filter technical characteristics according to IEEE 18 standard

After a few iterations, required technical characteristics (rated voltage and reactive power) of the observed filters are determined in a way to meet the limits given in [6]. Selected rated voltage and reactive power of filter for 5th harmonic are 27 kV / 50Mvar and for 7th harmonic filter 27 kV / 20 Mvar. The examined system is shown in Figure 2.1.

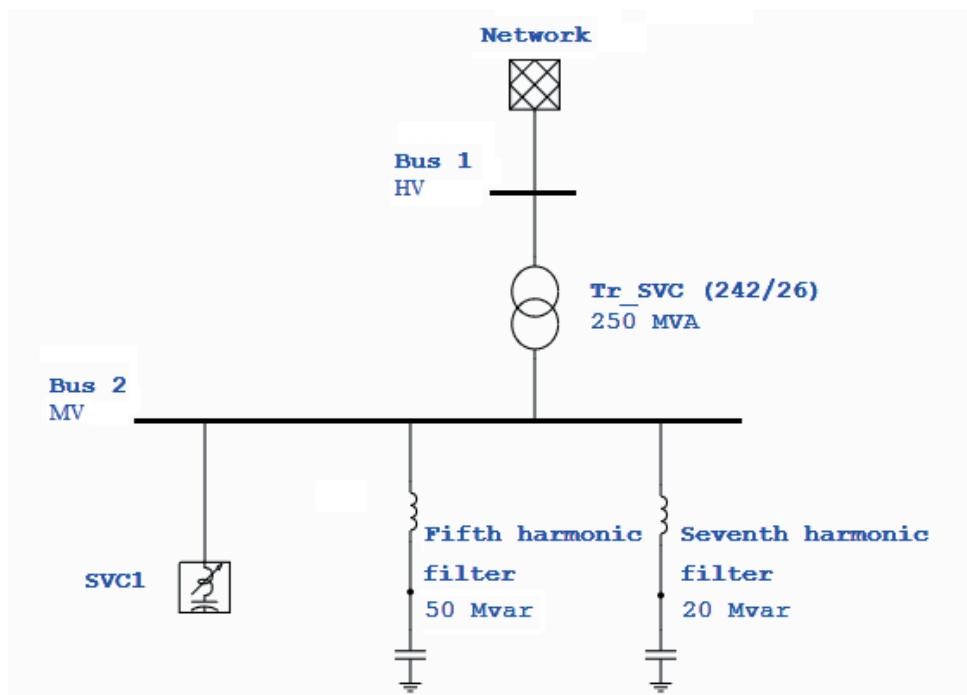

Figure 2.1 Equivalent scheme of system for analyzing SVC and filters interaction with the network

3. NETWORK FREQUENCY RESPONSE

Once the filter parameters are selected according to [6], it is necessary to check the parallel resonant conditions between filter branches and the inductive reactance of the network. If the parallel resonant frequency coincides with a characteristic harmonic present at network, resonant overvoltages are produced and this may cause insulation damage or failure of high voltage equipment. Using ETAP software, frequency scan of network is determined at the point of SVC connection to check the parallel resonant frequencies.

3.1. Parallel resonance

Parallel resonance is a result of interaction between capacitive and inductive parallel parts of network characterized by large impedance peak at frequency slightly below tuned filter frequency. A parallel resonance is to be established at a frequency:

$$f_{res} = \frac{1}{2\pi\sqrt{(L_s + L)C}} \quad (4)$$

where:

L and C are filter elements

L_s is source inductance.

3.2. Parallel resonance in the simplified network

Parallel resonant frequency would experience a shift whenever changes in the source inductance or in the filter elements occurs. Due to that, it is necessary to check parallel resonance for wider range of network operating conditions. Minimum and maximum short circuit current at bus 1 in network from Figure 2.1 are 10 kA and 20 kA, based on which the worst-case network impedance is calculated.

Frequency scan gives impedance amplitude and angle depending on frequency for the observed bus in the network. Results for bus 2 are shown in Figure 3.1 and Figure 3.2. From Figure 3.1, frequency response has four resonant frequencies in range 50-600 Hz, at which impedance angle is equal to 0° .

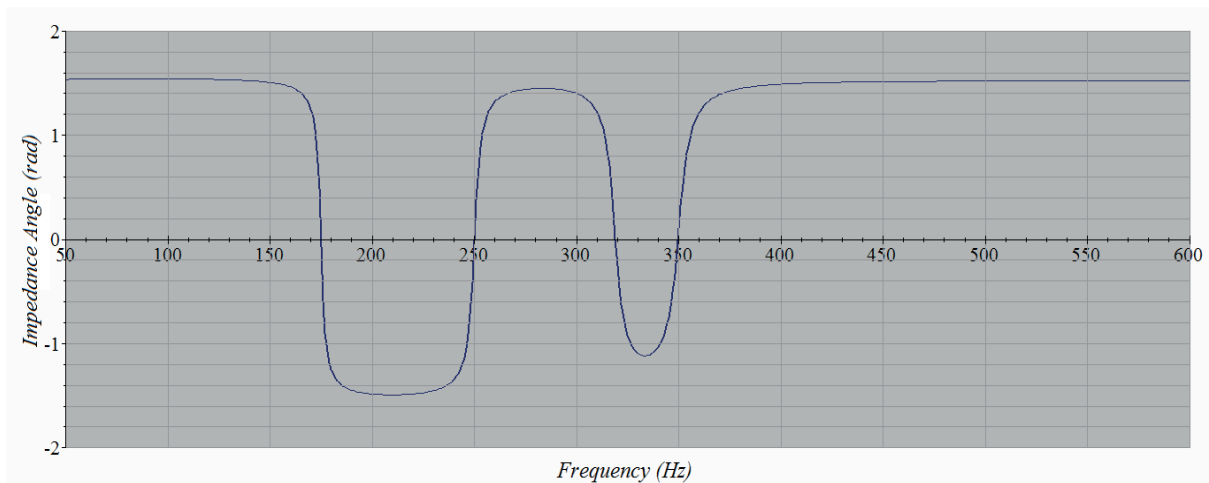

Figure 3.1 Impedance angle in dependence of frequency at point of SVC connection

Two peaks of impedance amplitude shown in Figure 3.2 correspond to parallel resonance between filter branches and network. Impedance amplitude is equal to 0 Ω at fifth and seventh harmonic frequencies which corresponds to series resonance, since filters are tuned at that frequencies.

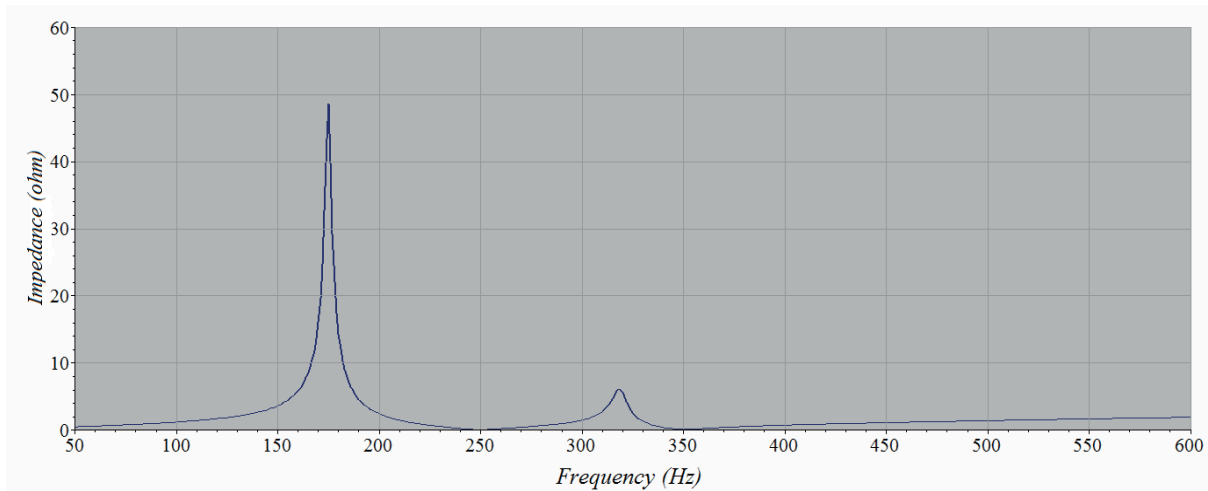

Figure 3.2 Impedance amplitude in dependence of frequency at point of SVC connection

Frequency scan results for minimum and maximum short circuit current are shown in Table III. Results show that higher short circuit current gives lower impedance magnitude at parallel resonant frequency.

Table III Resonant frequencies and impedance magnitudes at these frequencies

$I_{SC} = 20 \text{ kA}$			$I_{SC} = 10 \text{ kA}$		
Bus	Impedance magnitude	Resonant frequency	Bus	Impedance magnitude	Resonant frequency
Bus 2	48.51 Ω	175 Hz	Bus 2	55.68 Ω	168 Hz
Bus 2	6.1 Ω	318 Hz	Bus 2	6.42 Ω	317 Hz

3.3. Frequency scan in the real transmission network

In the previous chapter, short circuit impedance is used as a simplified representation of network. It was shown that filter branches lead to new resonant frequencies appearing. For more detail network frequency scan, so as more accurate assessment of filter influence on resonant conditions, it is necessary consider a more realistic model of transmission network.

Frequency scan at bus 1 is determined before and after filter connection at SVC substation considering real network model. Results of impedance magnitude in dependence of frequency are shown in Figure 3.3 and Figure 3.4.

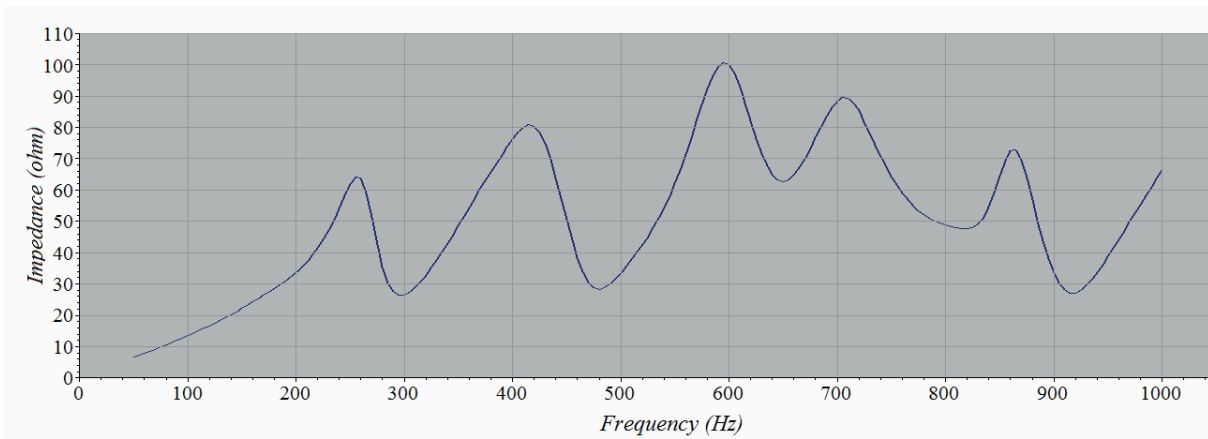

Figure 3.3 Impedance magnitude in dependence of frequency at bus 1 for real transmission network model

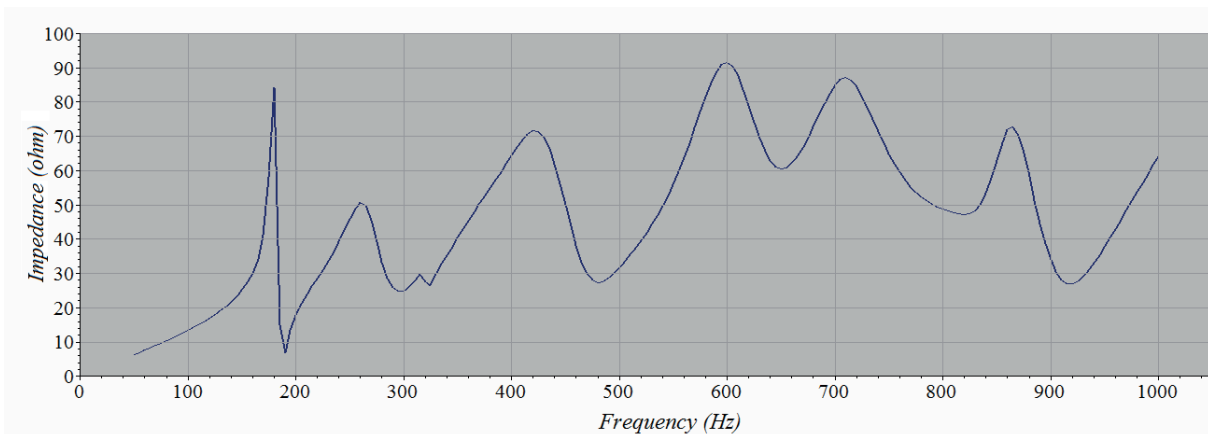

Figure 3.4 Impedance magnitude in dependence of frequency at bus 1 for real transmission network model with SVC and filters connected at bus 2

New parallel resonant frequencies after SVC and associated filters connection can be read off from above graphical results. Resonant frequencies and impedance magnitudes at bus 1 are given in Table IV.

Table IV Resonant frequencies and impedance magnitudes at bus 1 for model with real transmission network

Z [Ω]	f [Hz]
84.12	180.00
50.65	260.00
29.72	315.00
71.57	420.00
91.44	600.00
87.08	710.00
72.85	865.00

Real transmission network model in comparison to the simplified short circuit impedance model used in chapter 3.2 doesn't have great impact on resonant frequencies whilst higher impedance magnitudes at resonant frequencies can be noticed in the case of real network model.

4. HARMONIC POWER FLOW ANALYSIS

Depending on the network model complexity, harmonic analysis can be classified into balanced and unbalanced method. Assuming linear network model and linear harmonic sources, single-phase harmonic analysis is sufficient, and calculation applies the superposition principle so that harmonic sources are separately injected into each node of power system where harmonic distortions are created. Unbalanced harmonic sources require three-phase harmonic power flow calculation.

4.1. Harmonic characteristic of network

There can be multiple harmonic sources in the network, each contributing to harmonic distortion. It is necessary to check whether current harmonic distortions in the network for observed operating point are within defined limits.

Existing harmonic sources in the network can be modeled in ETAP software according to known, measured values of harmonic spectra. Current and voltage harmonic source models are available. Each harmonic component that observed source produces should be defined in percentage of nominal amplitude at fundamental frequency with associated phase angle.

4.2. Effect of harmonics generated by the SVC

In this section, voltage harmonic distortions of SVC, as the only harmonic source in the network, are presented. SVC is modeled as harmonic source according to previously described harmonic spectrum shown in Figure 1.2. Results of harmonic analysis, regarding total and individual harmonic distortions at observed buses are shown in Table V.

Table V Impact of SVC on voltage harmonic distortion

Bus 1 (20 kV)			Bus 2 (220 kV)		
THD = 6.92 %			THD = 1.27 %		
Harmonic order	Frequency (Hz)	IHD (%)	Harmonic order	Frequency (Hz)	IHD (%)
5	250	5.56	5	250	1.23
7	350	3.56	7	350	0.49
11	550	2.28	11	550	0.27
13	650	1.79	13	650	0.20
17	850	2.30	17	850	0.20

4.3. Impact of filters on voltage harmonic distortion

Harmonic load flow after connecting the fifth and seventh harmonic filter with above selected parameters, lead to reduction of total and individual harmonic distortions within defined limits. Results of harmonic analysis in case of SVC with connected filters are presented in Table VI.

Table VI Impact of filters on voltage harmonic distortion caused by SVC operation

Bus 1 (20 kV)			Bus 2 (220 kV)		
THD = 1.33 %			THD = 0.16 %		
Harmonic order	Frequency (Hz)	IHD (%)	Harmonic order	Frequency (Hz)	IHD (%)
5	250	0.13	5	250	0.03
7	350	0.15	7	350	0.02
11	550	0.83	11	550	0.11
13	650	0.74	13	650	0.09
17	850	1.01	17	850	0.09

5. CONCLUSION

The harmonic propagation of a SVC connected to a high-voltage transmission network has been analyzed in this paper. In order to reduce the negative influence of SVC operation on power quality, filters for fifth and seventh harmonic are selected due to their major impact in harmonic content from harmonics generated at the SVC terminals.

A method to obtain the filter parameters is presented. Once iterative process of filter parameters selection fulfills IEEE 18 standard it is necessary to carry out harmonic analysis. Harmonic analysis include frequency scan and harmonic load flow analysis whereby harmonic resonant existence and harmonic distortions in the network are analyzed. Connection of selected filter branches lead to appearance of two new parallel resonant frequencies at PCC. Frequency scan for real network model as result gives more accurate impedance amplitude at resonant frequencies in comparison to simplified network representation by short circuit impedance. Of special importance is to check that filter connection does not cause resonant points at harmonic frequencies, which frequency scan confirmed. Harmonic load flow analysis showed that IHD and THD are lower and within defined limits when using filters.

As conclusion, it can be highlighted that analysis method presented in this paper can be extended to any scenario and it is a useful tool for filter parameters determination and harmonic propagation analysis of power electronic devices connected to the transmission network.

REFERENCES

- [1] A. Gómez-Expósito, A. J. Conejo and C. Canizares, *Electric Energy Systems Analysis and Operation*, Boca Raton: CRC Press, 2009.
- [2] R. M. Mathur and R. K. Varma, *Thyristor-based FACTS Controllers for Electrical Transmission System*, New York: John Wiley & Sons, Inc. Publication, 2002.
- [3] C. Sankaran, *Power Quality*, New York: CRC Press LLC, 2002.
- [4] IEEE Std 519, *IEEE Recommended Practice and Requirements for Harmonic Control in Electric Power Systems*, New York, 2014.
- [5] F. De La Rosa, *Harmonics and power system*, Boca Raton: CRC Press, 2006.
- [6] IEEE Std 18, *IEEE Standard for Shunt Power Capacitors*, New York: IEEE, 2012.